



PS No.	PS-002-2023-019
Version	00
Date	2023/6/14

继电器规格书

RELAY SPECIFICATION

客户名称/Customer:

客户品名/Your Product Description:

客户零件编号/Your Part Number:

旺荣品名/Our Product Description: RJ-SS-112LM63-F

旺荣零件编号/Our Part Number:

客户批准/Customer Approval

盖章处/STAMPING AREA

发行批准 / Issued by			
编制 Make	审核 Check	安规会签 Countersign	批准 Approved

继电器规格书 Relay SPECIFICATION	型号 TYPE	RJ-SS-112LM63-F	产品编号 Part Number	
-------------------------------	------------	-----------------	---------------------	--

PS No.:

PS-002-2023-019

Ver

00

1 零件清单/PARTS LIST

No.	零件名 Part	材质 MATERIAL	型号/处理方式 TYPE/TREATMENT	UL FILE No. FLAME CLASS	备注 Remark
1	M端子 M Terminal	铜合金 Cu Alloy			
2	M接点 M Contact	银合金 Ag Alloy	AgSnO2		
3	可动接点 C Contact	银合金 Ag Alloy	AgSnO2		
4	C端子 C Terminal	铜合金 Cu Alloy			
5	推片 Card	LCP PBT			UL94 V-0
6	衔铁 Armature	铁 Steel	镀镍 Nickel Plated		
7	挂钩 Hinge	铜合金 Cu Alloy			
8	外壳 Case	PBT PET			UL94 V-0
9	骨架 Bobbin	PBT			UL94 V-0
10	线材 Wire	聚氨酯漆包圆铜线 Polyurethane copper wire	3UEW 155(F Class)	E164502 E234867 E363385	
11	铁架 Yoke	铁 Steel	镀镍 Nickel Plated		
12	铁芯 Core	铁 Steel	镀镍 Nickel Plated		
13	基座 Base	PBT PET			UL94 V-0
14	线圈端子 Coil Terminal	铜包钢 Cu coverd Steel	镀锡 Solder Coated		

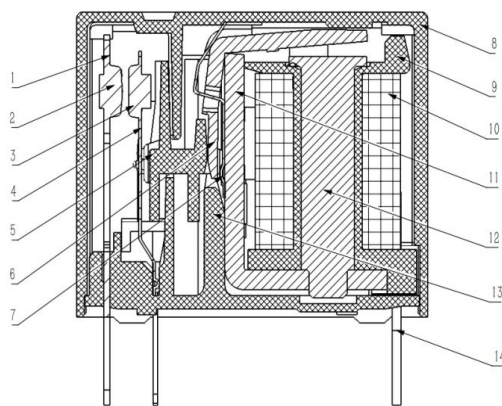

结构图Construction Schematic

继电器规格书 Relay SPECIFICATION	型号 TYPE	RJ-SS-112LM63-F	产品编号 Part Number
2. 性能/SPECIFICATIONS			
2.1 驱动部分/COIL SPECIFICATIONS			
2.1.1 额定电压 Rated Coil Voltage	12	VDC (在23°C时) VDC at 23°C	
2.1.2 额定功率 Nominal Power	0.2	W (在23°C时) W at 23°C	
2.1.3 线圈电阻 Coil Resistance	720	$\Omega \pm 10\%$ (在23°C时) $\Omega \pm 10\%$ (at 23°C)	
2.1.4 额定电流 Nominal Current	16.7	mA $\pm 10\%$ (在23°C时) mA $\pm 10\%$ (at 23°C)	
2.1.5 吸合电压 Operate Voltage	9	VDC以下 (在23°C时) VDC Max. at 23°C	
2.1.6 释放电压 Release Voltage	0.6	VDC以上 (在23°C时) VDC Min. at 23°C	
2.1.7 最大连续施加电压 Max Power	15.6	VDC Max. 130%额定电压 VDC Max. 130% of Nominal	
2.2 开关部/CONTACT SPECIFICATION			
2.2.1 开关类型 Contact Configuration	一组常开型 1 Form A		
2.2.2 接点规格 Contact Rating	16	A 277VAC (阻性负载) A @277VAC (Resistive)	
2.2.3 接触电阻 Contact Resistance	100	m Ω 以下, (初期值, DC 6V/1A条件下) m Ω Max. @ Initiate, DC 6V/1A	
	500	m Ω 以下, (寿命试验后, DC 6V/1A条件下) m Ω Max. @ After Life, DC 6V/1A	
2.2.4 吸合时间 Operate Time	8	ms 以下 (额定电压下) ms Max. @ Rated Voltage	
2.2.5 释放时间 Release Time	5	ms 以下 (施加额定电压后断开时) ms Max. @ Rated Voltage	
2.2.6 最大动作频率 Max. Switching Rate	300	次/分 (无负载) ops./min. (no load).	
	6	次/分 (额定负载) ops./min. (Rated load)	
2.3 特性/GENERAL SPECIFICATION			
2.3.1 绝缘电阻 Insulation Resistance	1000	M Ω 以上 (500VDC) M Ω Min@500VDC	
2.3.2 介质耐压 Dielectric Strength	1000	VAC/分钟(接点间)	
	4000	VAC/分钟(线圈/接点间)	
	1000	VAC@50/60Hz 1 min.(Between Open Contacts)	
	4000	VAC@50/60Hz 1 min.(Between Coil and Contacts)	

PS No.: PS-002-2023-019

Ver

00

继电器规格书 Relay SPECIFICATION	型号 TYPE	RJ-SS-112LM63-F	产品编号 Part Number
2.3.3 电气寿命 Electrical Life		5×10 ⁴ 次以上 (常温, 额定负载, 通断比: 1s:9s) 5×10 ⁴ Cycle Min. @Room Temperature,Rate Load,ON:OFF: 1s:9s)	
2.3.4 机械寿命 Mechanical Life		1×10 ⁶ 次以上 (无负载) 1×10 ⁶ Cycle Min. @no load	
2.3.5 线圈温升 Coil Temperature Rise:		70K Max. (线圈电压: 110%, 额定负载, 环境温度: 85℃) 70K Max. (Coil Voltage:110%,Rate Load, Environmental Temperature:85℃)	
2.3.6 使用环境温度 Temperature		-40~85 ℃ (无凝结时) -40~85 ℃ @no condensation	
2.3.7 使用环境湿度 Humidity		5~85% RH (无凝结时) 5~85% RH @no condensation	
2.3.8 抗振动 Vibration	耐久 Mechanical	10~55 Hz, 双振幅 1.5mm 10 to 55 Hz, 1.5mm double amplitude	
	误动作 Operational	10~55 Hz, 双振幅1.5mm 10 to 55 Hz, 1.5mm double amplitude	
2.3.9 抗冲击 Shock	耐久 Mechanical	980 m/s ² Min (约100G) 980 m/s ² Min (100G approximately)	
	误动作 Operational	98 m/s ² Min (约10G) 98 m/s ² Min (10G approximately)	
2.3.10 重量约 Weight About		5.7 克 5.7 g	
2.3.11 焊锡条件 Solder ability		5s @ 260℃ (波峰焊) 5s @ 260℃ (wave soldering)	
2.3.12 储存条件 Storage conditions		温度-40℃~+85℃, 湿度20 to 80%RH temperature:-40℃~+85℃, humidity:20 to 80%RH	
2.4 端子性能/TERMINAL CHARACTERISTICS			
2.4.1 端子强度 Terminals strength		5牛/10秒, 任意方向静态压力, 无异常, 但端子弯曲可以 5N 10s,There shall be no abnormalities. (The curving of the terminal shall be acceptable)	
2.4.2 可焊性 Terminal solderbility		260±5℃ 3s, 端子头部90%以上的面积有锡覆盖 (无铅焊锡) 260±5℃ 3s, In Case of lead lead free solder, 90% of the dipped portion shall be solderd.	
2.4.3 耐热性 Soldring Heat Resistance		10s @ 260℃,端子头部3mm浸入锡中, 无异常发生 10s @ 260℃,There shall be no abnormalities. (wave soldering)	
2.5 耐温性/Temperature Resistance			
2.5.1 耐热 Heat Resistance		(85±5) ℃, 16h, 恢复常温2h, 无异常发生 (85±5) ℃, 16h, Room Temperature:2h, There shall be no abnormalities.	
2.5.2 耐寒 Cold Resistance		(-40±2) ℃, 16h, 恢复常温2h, 无异常发生 (-40±2) ℃, 16h, Room Temperature:2h, There shall be no abnormalities.	
2.6 耐湿性/Moisture Resistance		(40±2) ℃, RH:90%~95%,16h, 恢复常温2h, 无异常发生, 绝缘电阻≥50MΩ (500VDC) (40±2) ℃, RH:90%~95%,16h, Room Temperature:2h, There shall be no abnormalities.Insulation Resistance:≥50MΩ (500VDC)	

PS No.:

PS-002-2023-019

Ver

00

继电器规格书 Relay SPECIFICATION	型号 TYPE	RJ-SS-112LM63-F	产品编号 Part Number
-------------------------------	------------	-----------------	---------------------

PS No.: PS-002-2023-019 Ver 00

2.7 安全规格/SAFETY REQUIREMENTS

2.7.1 UL规格认定 (UL & C-UL) 档案号: E345228
 UL (UL & C-UL) File No.: 

2.7.2 CQC标志认证 证书编号: CQC16002139598
 CQC Certificate No.: 

2.7.3 TUV规格认定 证书号: R 50222701
 TUV Certificate No. 

2.7.4 产品符合ROHS和REACH要求。
 The product meets the requirements of ROHS & REACH.

3. 捺印图/Mark Layout

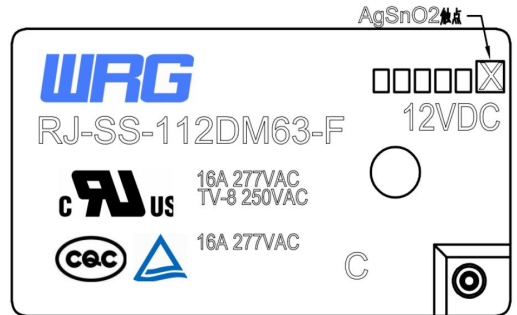

印字方式: 激光印字
 Printing: laser printing.

Batch No. Identification:

H □ □ □ □
 1 2 3 4

- 1、Manufactory:
Blank: Shenzhen; H: Huangshan
- 2、Year
The last two digits of the year.
- 3、Week
Production of the current week.
- 4、Lot No.
(A,B,C,.....Z) OR (AA,BB,CC,.....ZZ)

继电器规格书 Relay SPECIFICATION	型号 TYPE	RJ-SS-112LM63-F	产品编号 Part Number
5 订货标记/Ordering Information			
RJ - SS - 1 12 L M 6 3 - F			
① ② ③ ④ ⑤ ⑥ ⑦ ⑧ ⑨			
① 产品型号 Model designation RJ			
② 保护结构 Construction type SS:PCB端子密封 (PCB Terminal sealed)			
③ 接点组数 Number of poles 1:1组 (1 pole)			
④ 线圈电压 Coil voltage 12:12V			
⑤ 功率 Coil Power L:0.2W			
⑥ 接点结构 Contact configuration M:常开型 (Form A)			
⑦ 接点负载 Contact rating 6:16A			
⑧ 接点材质 Contact Material			
⑨ 绝缘系统等级 Insulation system F:Class F			
6 其他说明/Others			
6.1 除非特别申明, 测试或试验的标准环境条件如下:			
Unless otherwise explicitly stated, the standard environment conditions for measurement or testing are			
listed as following:			
6.1.1 环境温度: 23±5℃			
Ambient temperature is 23±5℃			
6.1.2 大气压力: 96±10%kPa			
Atmospheric pressure is 96±10%kPa			
6.1.3 相对湿度: 25%~75% RH			
Relative humidity is 25%~75% RH			
6.2 非密封型继电器需要防止助焊剂或污染物进入继电器			
Unsealed relays should prevent flux or contamination into the relay.			
6.3 密封型继电器/Sealed relay			
6.3.1 对于密封型产品, 在焊接完成后, 如果需要进行清洗, 请告知敝司。			
Regarding the sealed relays, If cleaning is necessary after welding, please contact us.			
6.3.2 推荐在室温条件下, 尽可能短的时间内完成清洗过程。不建议用热水清洗塑胶外壳型继电器, 因为水可能进入继电器。			
It will be recommendable to make washing process in possible short time with normal room			
temperature solution. Washing process by hot water is not recommendable for plastic cased			
relay as the water immersion-problem into relay may be caused.			
6.3.3 不建议用超声波清洗设备清洗塑胶外壳型继电器, 因为继电器触点可能被超声波能量轻微粘滞。			
Ultraonic washing machine's cleaning for plastic cased relay is not recommendable as the			
relay's contact may be slightly stuck by ultrasonic wave energy.			
6.4 避免在强磁条件下使用继电器, 外界磁场会造成继电器动作和释放等参数发生变化。			
To avoid using the relays under strong magnetic field because it will change the parameters of relay			
such as pull-in and drop-out voltage.			
6.5 为了保持继电器的性能, 请注意不要使继电器掉落或受到强冲击。掉落后的继电器建议不要使用。			
To maintain the performances of relays, please do not make the relay drop or be shocked strongly.			
Suggest that the relays dropped not be used.			
注/Remark			
以中文版为准, 英文版仅供参考。			
Chinese version is the standard one, English version is only for information.			
结束/<END>			

PS No.: PS-002-2023-019 Ver 00

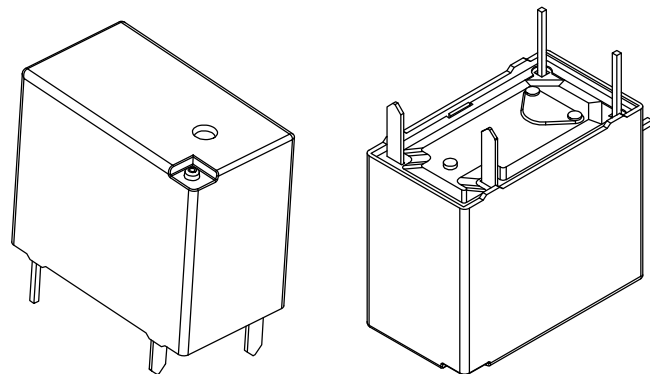

主视图

侧视图

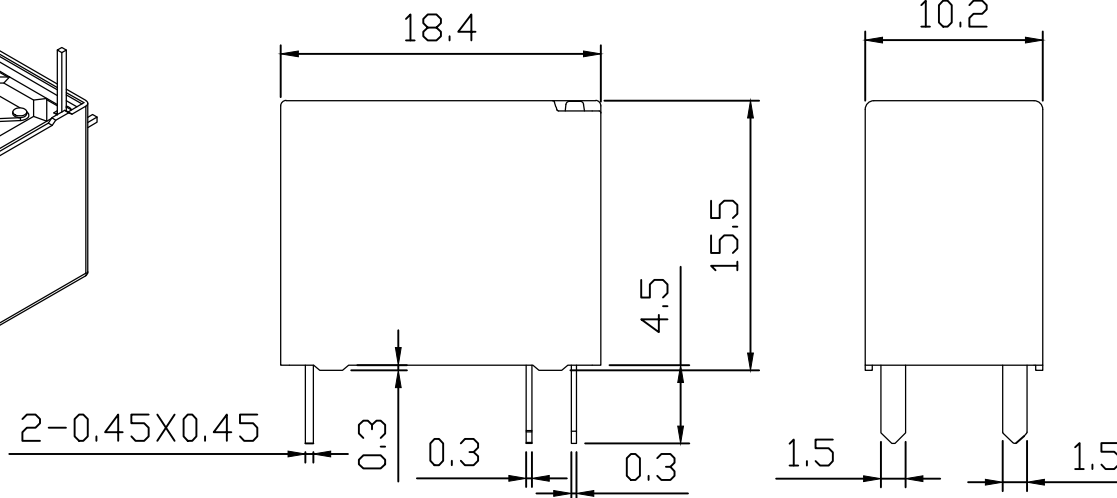

安装孔尺寸

(底视图)

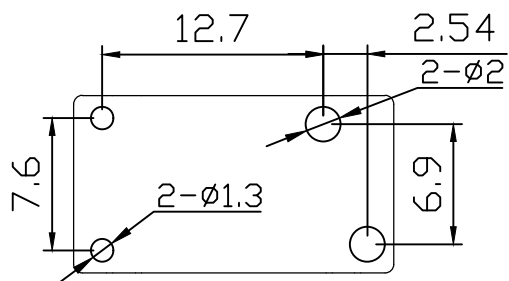

接线图

(底视图)

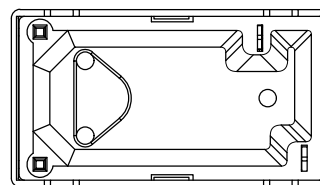
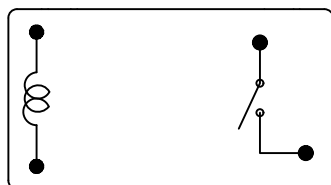

型号	RJ	首版制图日期	承认	检图	制图
公差/TOLERANCES (. mm)		作图日期	冯旭强	陈选政	刘维智
<1	±0.2	比例	版本	名称 RJ 16A外观图	
1-5	±0.3		V1.0		
>5	±0.4	1:1	页数	图号	
			1/1	U-002-08	

